

THERMAL INSTRUMENT Co.

217 Sterner Mill Road, Treose, PA 19053

Telephone No. (215) 355-8400

FAX No. (215) 355-1789

Email: office@thermalinstrument.com

INSTALLATION, OPERATION & CALIBRATION INSTRUCTIONS FOR THERMAL FLOW METER

MODEL:

926 REMOTE ELECTRONICS

220VAC

110VAC

24 VDC

Factory Set

INSTALLATION - MODEL 600-9

FIGURE (5) IS AN OUTLINE DRAWING OF THE FLOW TRANSDUCER, SHOWING FLOW CONNECTIONS AND MOUNTING DIMENSIONS.

ALL FLOW WETTED PARTS ARE TYPE: _____

THE FLOW TRANSDUCER CAN BE MOUNTED HORIZONTALLY OR VERTICALLY, HOWEVER, WHEN MOUNTED VERTICALLY FLOW DIRECTION MUST BE UPWARDS. THE FLOW SHOULD ENTER AT THE PORT MARKED "IN" AND EXIT AT THE PORT MARKED "OUT".

THE METER SHOULD BE INSTALLED IN A STRAIGHT LINE. THIS LINE SHOULD PREFERABLY BE THE SAME DIAMETER AS THE METER TUBE OR PIPE. THIS STRAIGHT LINE SHOULD HAVE A MINIMUM LENGTH OF TEN (10) DIAMETERS AHEAD OF THE METER. LIKewise, A STRAIGHT LENGTH OF THE PIPE OR TUBE AFTER THE METER SHOULD BE AT LEAST A LENGTH OF FIVE (5) PIPE DIAMETERS.

WHERE PHYSICAL CONDITIONS PREVENT THIS, INFORM US IN ADVANCE AND WE WILL CALIBRATE THIS METER UNDER ACTUAL OPERATING CONDITIONS.

ENCLOSED IS A _____ FOOT LENGTH OF 4 CONDUCTOR SHIELDED CABLE FOR INTERCONNECTING THE SIGNAL CONDITIONER AND TRANSDUCER.

NOTE: THIS UNIT IS INDEPENDENT OF CABLE LENGTH.

FIGURE (6) IS A SKETCH SHOWING THE ELECTRONICSIGNAL CONDITIONER AND REQUIRED ELECTRICAL CONNECTIONS.

FIGURE (9) SHOWS THE OVERALL EXTERNAL WIRING CONNECTIONS.

THE SIGNAL CONDITIONER REQUIRES _____ VOLTS (50 to 60 CYCLES AC Only).

REGULATION IS VALID OVER _____ TO _____ VOLTS AC.

THE OUTPUT SIGNAL FOR FULL SCALE FLOW RATE IS 20 MA DC ISOLATED.

INSTALLATION - MODEL 62-9

FIGURE (5) IS AN OUTLINE DRAWING OF THE FLOW TRANSDUCER, SHOWING FLOW CONNECTIONS AND MOUNTING DIMENSIONS.

ALL FLOW WETTED PARTS ARE TYPE: _____.

THE METER SHOULD BE INSTALLED INTO A STRAIGHT LINE. THIS STRAIGHT LINE SHOULD HAVE A MINIMUM LENGTH OF TEN (10) DIAMETERS AHEAD OF THE METER. LIKewise, A STRAIGHT LENGTH OF THE PIPE OR TUBE AFTER THE METER SHOULD BE AT LEAST A LENGTH OF FIVE (5) PIPE DIAMETERS.

WHERE PHYSICAL CONDITIONS PREVENT THIS, INFORM US IN ADVANCE AND WE WILL CALIBRATE THIS METER UNDER ACTUAL OPERATING CONDITIONS.

ROTATE INDEX ARROW TO FACE TOWARD FLOW.

ENCLOSED IS A _____ LENGTH OF 4 CONDUCTOR SHIELDED CABLE FOR INTERCONNECTING THE SIGNAL CONDITIONER AND TRANSDUCER.

NOTE: THIS UNIT IS INDEPENDENT OF CABLE LENGTH.

FIGURE (6) IS A SKETCH SHOWING THE ELECTRONIC SIGNAL CONDITIONER AND REQUIRED ELECTRICAL CONNECTIONS.

FIGURE (9) SHOWS THE OVERALL EXTERNAL WIRING CONNECTIONS.

THE SIGNAL CONDITIONER REQUIRES _____ VOLTS AC _____ CYCLES. (50 to 60 CYCLES AC Only)

REGULATION IS VALID OVER _____ TO _____ VOLTS AC.

THE OUTPUT SIGNAL FOR FULL SCALE FLOW RATE IS 20 MA DC ISOLATED.

OPERATION

MODEL 600-9 AND 62-9

WITH ALL CONNECTIONS HAVING BEEN COMPLETED AND TESTED, A SHORT BUT FAST FLOW RATE SHOULD BE OBTAINED IN ORDER TO CLEAN GAS BUBBLES AND IMPURITIES FROM THE FLOW TUBE.

APPLY POWER AND ALLOW A TEN (10) MINUTE WARM-UP PERIOD.

FIGURE 6 (SEE SPECIFIC CURVE DOCUMENT VIA METER MANUAL) IS A CALIBRATION CURVE CORRELATING FLOW VERSUS INDICATION. THE OUTPUT SIGNAL FOR FULL FLOW RATE IS 20 MA DC. WHEN A FACTORY CALIBRATION IS PROVIDED, IT SHOULD NOT BE NECESSARY TO PERFORM A FIELD CALIBRATION. IF, HOWEVER, IN THE FUTURE IT SHOULD BE DECIDED TO USE THE METER WITH FLUIDS FOR WHICH THE DEVICE HAS NOT BEEN CALIBRATED, FIELD CALIBRATION INSTRUCTIONS ARE INCLUDED.

IN THE CASE OF MULTIPLE CALIBRATIONS IT IS NECESSARY TO SET THE CALIBRATION DIALS AND SWITCHES FOR THE FLUID AND/OR RANGE DESIRED, IN ACCORDANCE WITH THE SETTINGS PROVIDED ON THE CALIBRATION CURVES.

FIELD CALIBRATION CHECK THREE TERMINAL STRIP MODEL 926

The three terminal strip 926 electronic signal conditioner output can be calibrated by simulating the voltage output of the flow element with an external variable D.C. voltage source.

1. Turn power off at electronics.
2. Disconnect flow transducer cable from electronics terminal 1, 2, 3, 4 & 5. Note the wiring labeling and/or colors for placing back on correctly later.
3. Connect an external variable DC voltage source to terminals "2" and "3" (negative) and "4" (positive) of electronics.
NOTE: Terminals "2" and "3" must be connected together.
4. Apply power to electronics.
5. With 0 Volts from the DC Voltage source, the mA should be clamped at 4.00 mA. If it is not correct, Adjust I Zero Potentiometer R4 until 4.00 mA. R4 is located above the 7-pin terminal strip to the far right.
6. Locate calibration data sheet in the instruction manual "Component Values Determined at Calibration".
7. Turn on the DC Voltage source and set the voltage beyond the full scale EXC voltage (1 volt higher for example). The mA output should clamp at 20.00 mA. If it is not correct, then Adjust I Span Potentiometer R6 until 20.00 mA. R6 is located above the 7-pin terminal strip to the far right.
8. You may have to go back to step 5 and repeat the procedure due to the I Zero and the I Span offset each other a little.
9. Set the DC Voltage source for 10% transducer output (EXC Voltage). Milliamp output should be 10%, 5.6 mA. If it is not correct, Adjust F Zero Potentiometer R35 until 5.6 mA. R35 is located on the Range Board, which is to the left of the Main Board and above the 3-pin terminal strip (110 VAC connection).
10. Set the DC Voltage source for 90% transducer output (EXC Voltage). The mA output should be 18.4 mA. If it is not correct, Adjust F Span Potentiometer R33 until 18.4 mA. R33 is also located on the Range Board.
11. You may have to go back to step 9 and repeat the procedure due to the F Zero and the F Span offset each other a little.
12. After 10% and 90% are set check 0, 20, 30, 40, 50, 60, 70, 80, and 100%.
13. If the output is satisfactory, continue to next step, otherwise recheck steps taken and if necessary contact Thermal Instrument Company for further instructions.
14. Turn power off at electronics.
15. Remove the DC Voltage source and reconnect the transducer cable.
16. Apply power to the electronics. The meter should now be in normal operation.

FIELD CALIBRATION CHECK TWO TERMINAL STRIP MODEL 926

The two terminal strip 926 electronic signal conditioner output can be calibrated by simulating the voltage output of the flow element with an external variable D.C. voltage source.

1. Turn power off at electronics.
2. Disconnect flow transducer cable from electronics terminal 1, 2, 3, 4 & 5. Note the wiring labeling and/or colors for placing back on correctly later.
3. Connect an external variable DC voltage source to terminals "3" (negative) and "4" (positive) of electronics.
4. Apply power to electronics.
5. With 0 Volts from the DC Voltage source, the mA should be clamped at 4.00 mA. If it is not correct, Adjust I Zero Potentiometer R30 until 4.00 mA.
6. Locate calibration data sheet in the instruction manual "Component Values Determined at Calibration".
7. Turn on the DC Voltage source and set the voltage beyond the full scale EXC voltage (1 volt higher for example). The mA output should clamp at 20.00 mA. If it is not correct, then Adjust I Span Potentiometer R32 until 20.00 mA.
8. You may have to go back to step 5 and repeat the procedure due to the I Zero and the I Span offset each other a little.
9. Set the DC Voltage source for 10% transducer output (EXC Voltage). The mA output should be 10%, 5.6 mA. If it is not correct, Adjust F Zero Potentiometer R13 until 5.6 mA.
10. Set the DC Voltage source for 90% transducer output (EXC Voltage). The mA output should be 18.4 mA. If it is not correct, Adjust F Span Potentiometer R11 until 18.4 mA.
11. You may have to go back to step 9 and repeat the procedure due to the F Zero and the F Span offset each other a little.
12. After 10% and 90% are set check 0, 20, 30, 40, 50, 60, 70, 80, and 100%.
13. If the output is satisfactory, continue to next step, otherwise recheck steps taken and if necessary contact Thermal Instrument Company for further instructions.
14. Turn power off at electronics.
15. Remove the DC Voltage source and reconnect the transducer cable.
16. Apply power to the electronics. The meter should now be in normal operation.

Troubleshooting

Troubleshooting of a malfunctioning flow meter is a process of isolating the particular circuit area which is out of range and then finding the components causing the failure. Before looking into possible circuit problems it will be profitable in most cases to first determine that the problem is not internal to the electronics. As odd as it may sound, most apparent flow meter malfunctions are a result of incorrect installation or changes in process operating conditions.

Typical installation problems are:

- Fluid not flowing.
- Flow rate or temperature out of calibration range.
- Fluid not identical to calibration fluid.
(Ex: Air instead of CO2 or Water instead of Glycol)
- Fluid has coated flow element.
(Ex: Very dirty gas or liquid that leaves a film or layers)
- Flow element installed too close to upstream or downstream flow disturbance.
(Minimum 10 pipe diameters upstream and 5 pipe diameters downstream)
- Power not on or incorrect voltage.
(Ex: Connecting 24 VDC in place of 110 VAC)
- Flow element wiring incorrect.
- Output wiring incorrect.

Figure #1

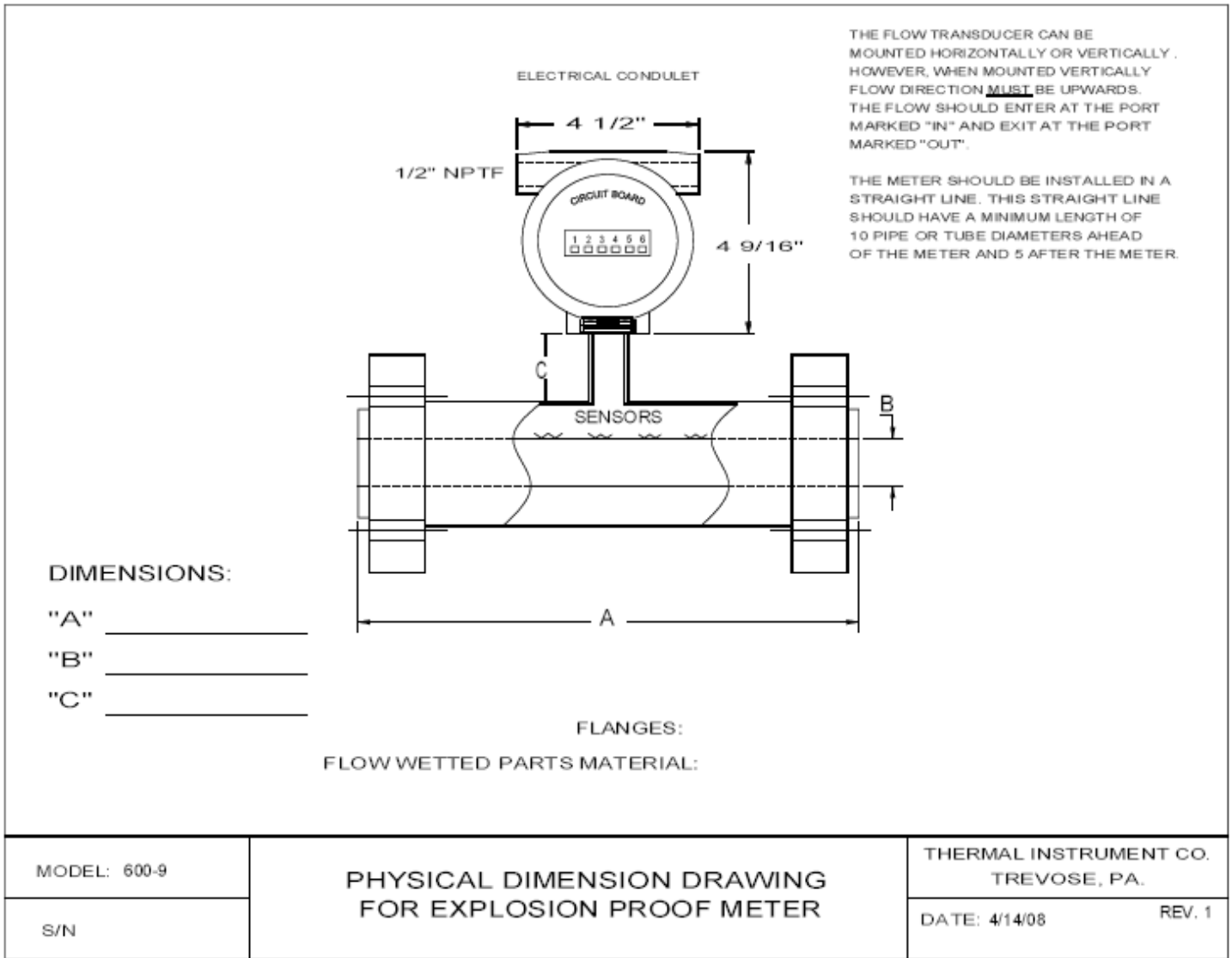
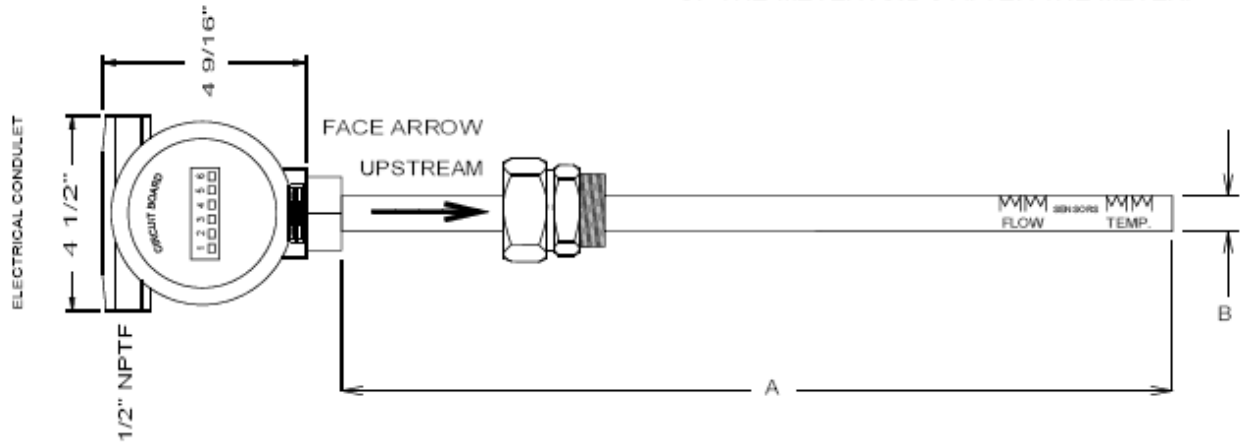

Figure #2



THE METER SHOULD BE INSTALLED IN A STRAIGHT LINE. THIS STRAIGHT LINE SHOULD HAVE A MINIMUM LENGTH OF 10 PIPE OR TUBE DIAMETERS AHEAD OF THE METER AND 5 AFTER THE METER.

DIMENSIONS:

A: _____

B: _____

MATERIAL: _____

PACKING GLAND:

MATERIAL: Stainless Steel

INSERT: TEFLON

THREADS: _____

MODEL: 62-9	PHYSICAL DIMENSIONS OF FLOWPROBE	THERMAL INSTRUMENT CO. TREVOSE, PA.	
S/N		DATE:	REV. 1 TIC-341-9

Figure #3

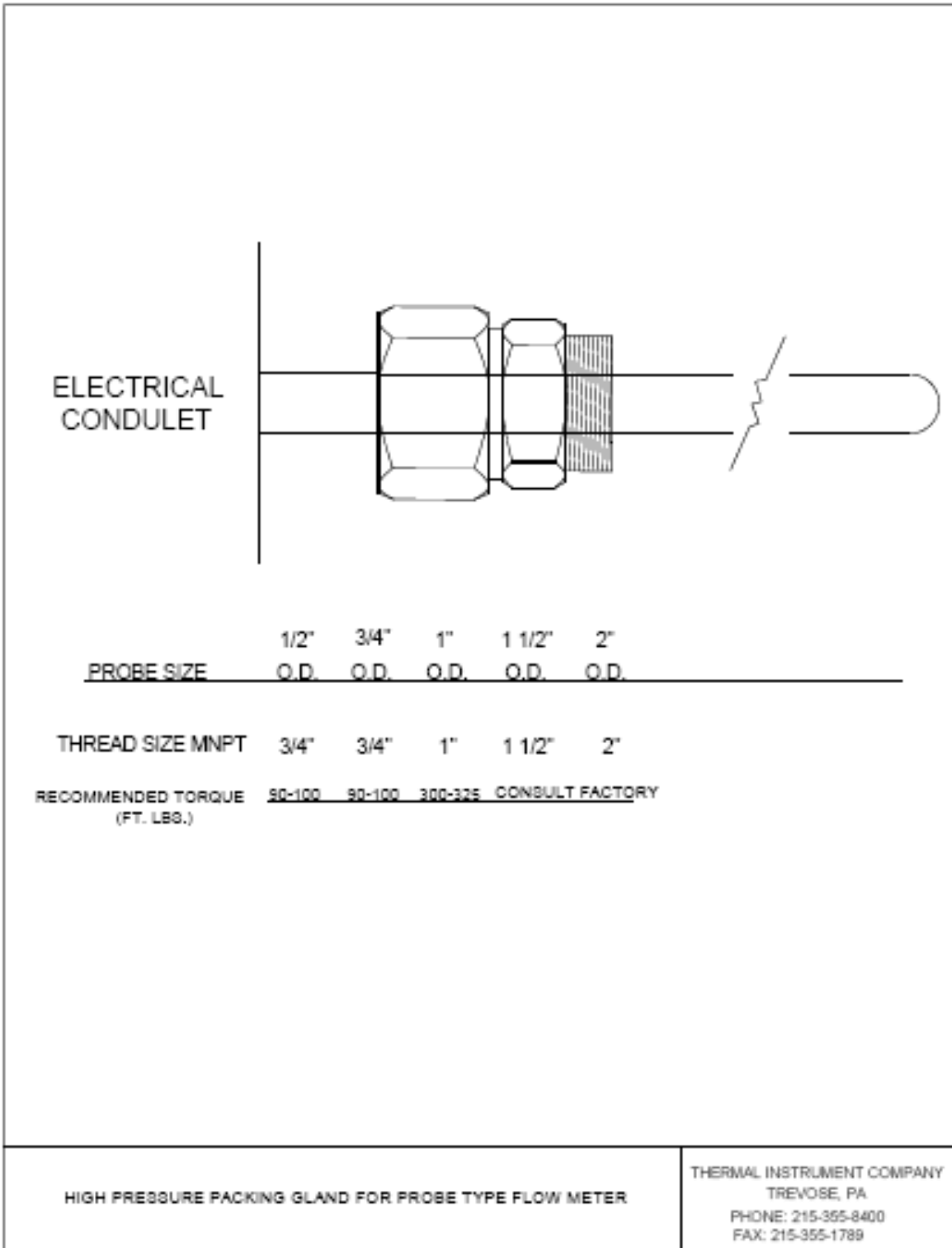

HIGH PRESSURE PACKING GLAND FOR PROBE TYPE FLOW METER

THERMAL INSTRUMENT COMPANY
 TREVOSE, PA
 PHONE: 215-355-8400
 FAX: 215-355-1789

Figure #4

THE METER SHOULD BE INSTALLED IN A STRAIGHT LINE. THIS STRAIGHT LINE SHOULD HAVE A MINIMUM LENGTH OF 10 PIPE OR TUBE DIAMETERS AHEAD OF THE METER AND 5 AFTER THE METER.

RECOMMENDED INSERTION LENGTHS

LINE SIZE I.D.	PROBE TIP INSERTION LENGTH
2"	1 3/4"
3"	2 3/4"
4"	3 3/4"
5"	4 3/4"
6"	5 3/4"
7"	6 3/4"
8"	7 1/2"
10"	8 1/2"
12"	9 1/2"
16"	11 1/2"
18"	12 1/2"
24"	15 1/2"
30"	18 1/2"
36"	21 1/2"
48"	27 1/2"

"L" - DIMENSION (HEIGHT OF CONNECTION) SUPPLIED BY CUSTOMER

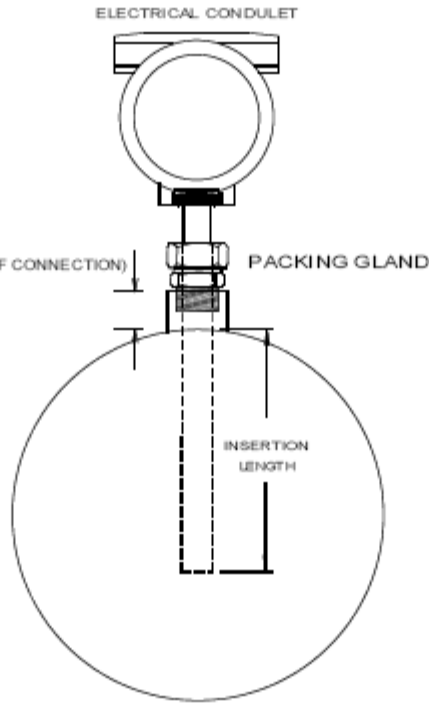

PACKING GLAND:

MATERIAL: STAINLESS STEEL
 INSERT: TEFLON
 THREADS: 3/4" MNPT

PROBE DIAMETER: 1/2" O.D.

PROBE MATERIAL: 316 S.S.

MODEL: 62-9	PROBE INSTALLATION	THERMAL INSTRUMENT CO. TREVOSE, PA.
		DATE: 4/14/08

Figure #5

CONDULET

1/2" NPTF

CIRCUIT BOARD

- 5 BLUE
- 5 SHIELD
- 4 GREEN
- 3 BLACK
- 2 RED
- 1 WHITE

YEL

- BLUE
- 0 A
- 0 B
- 0 C
- 0 C1
- 0 D

1/2" PIPE

CONNECTING WIRES
TO TERMINAL STRIP
DO NOT REMOVE BOARD
INSTEAD, GENTLY
REMOVE GREEN TERMINAL
STRIP

TRANSDUCER TYPE: _____

TRANSDUCER SIZE: _____

TRANSDUCER MOUNTING: _____

TRANSDUCER ROTATION: _____

CONDULET TYPE: XIHX SERIES

CONDUIT SIZE: 1/2" NPTF

CABLE TYPE: _____

CABLE LENGTH: _____

SENSOR RESISTANCE @ AT 75 °F

A-B 50

A-B1 50 SPARE FLOW

C-D 100 WITH SHUNT

C1-D 100 SPARE TEMP.

ALL GROUND ∞

TO CONNECT SPARE FLOW
MOVE BLUE JUMPER FROM B TO B1

TO CONNECT SPARE TEMP.
MOVE YELLOW JUMPER FROM C TO C1

NOTE:
MAKE SURE TRANSDUCER
BODY IS GROUNDED.

MODEL:	FLOW TRANSDUCER	THERMAL INSTRUMENT CO. TREVISO PA
S/N	ELECTRICAL CONNECTIONS FOR MODEL 926 AND 9200 ELECTRONICS	DATE: 4/14/08 REV. 1

12 | Page

Revision: 7/10/2008

Figure #6

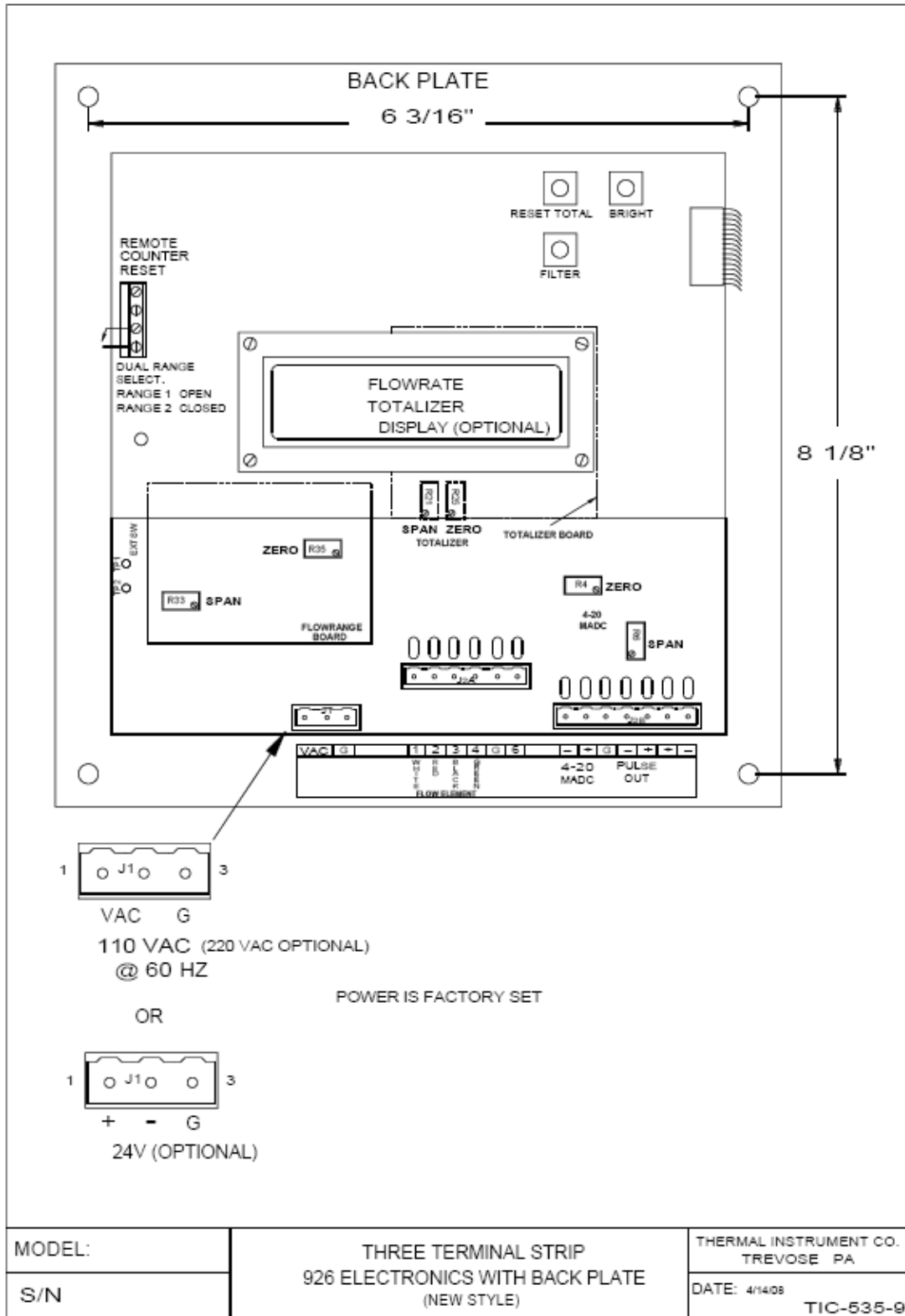
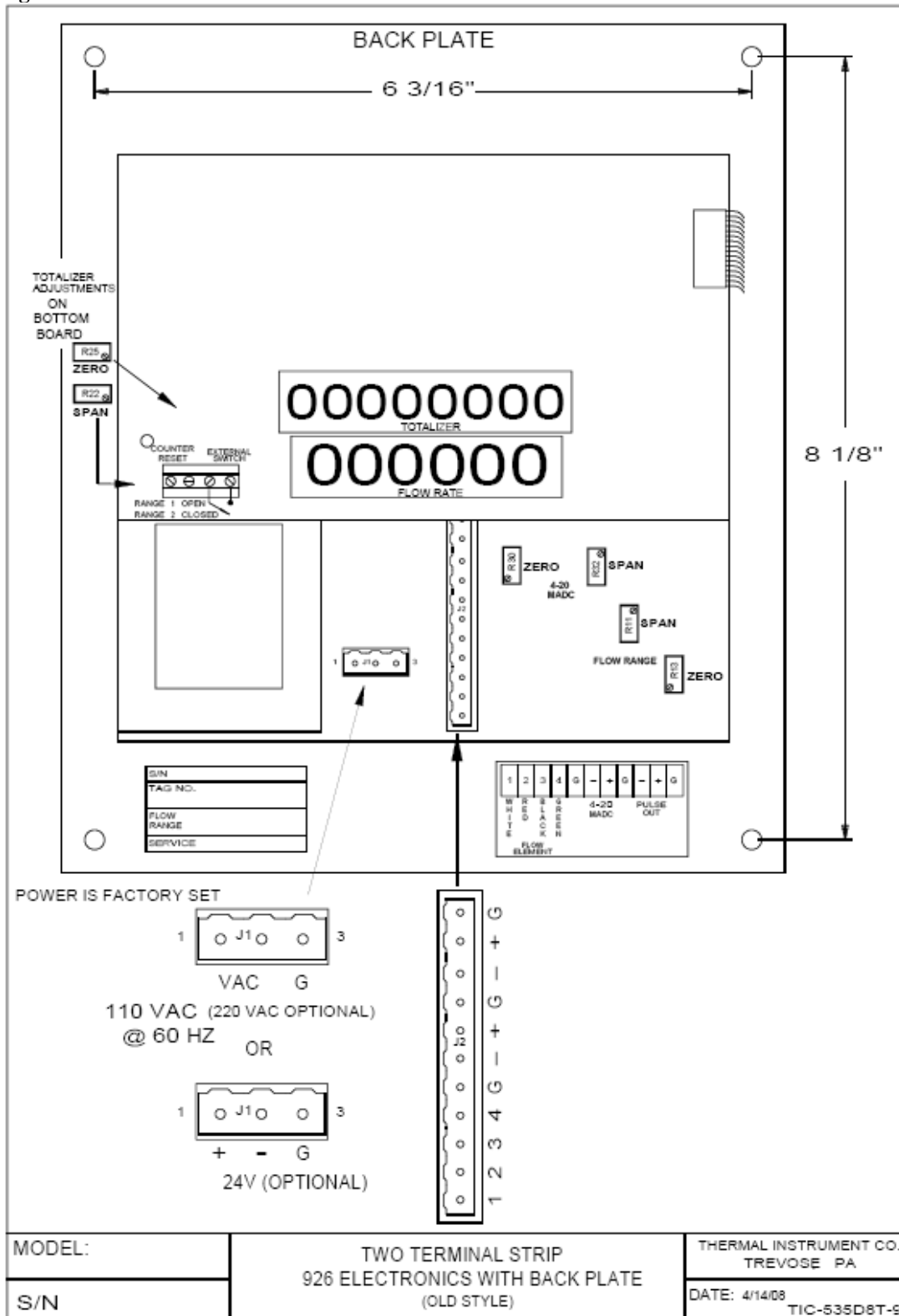

Figure #7



MODEL:
S/N

TWO TERMINAL STRIP
926 ELECTRONICS WITH BACK PLATE
(OLD STYLE)

THERMAL INSTRUMENT CO.
TREVOSÉ PA
DATE: 4/14/08
TIC-535D8T-9

Figure #8

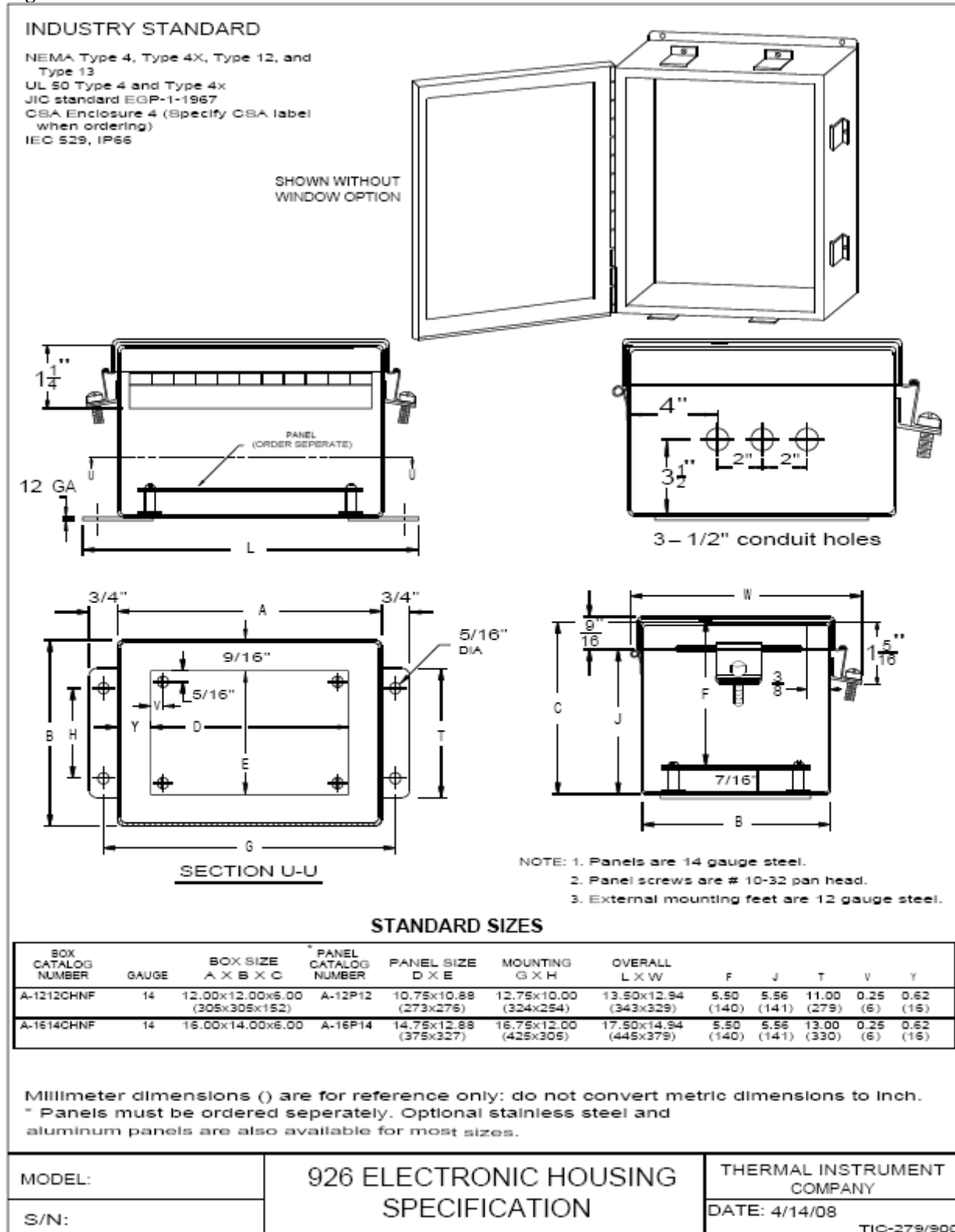

Figure #9

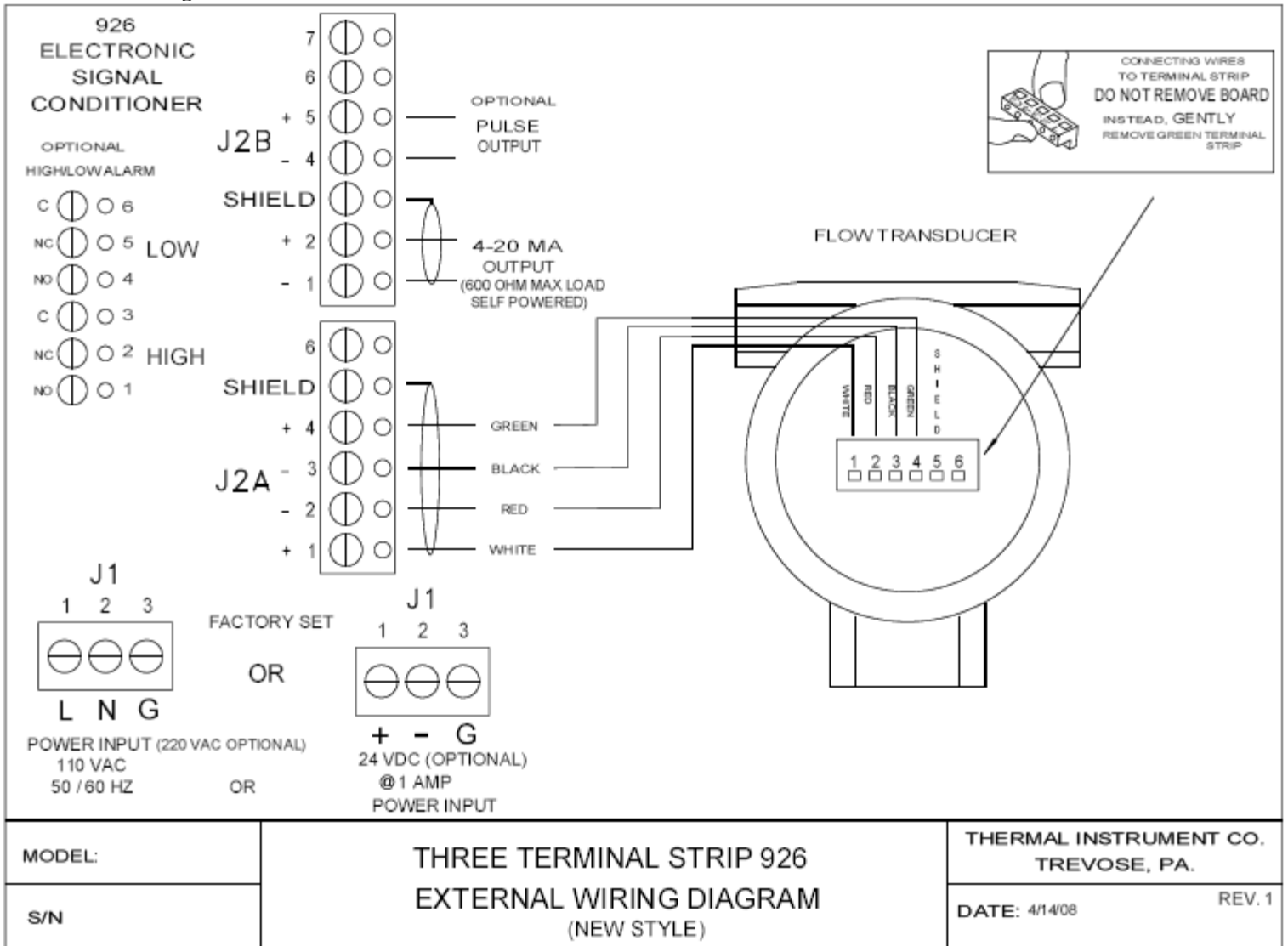

Figure #10

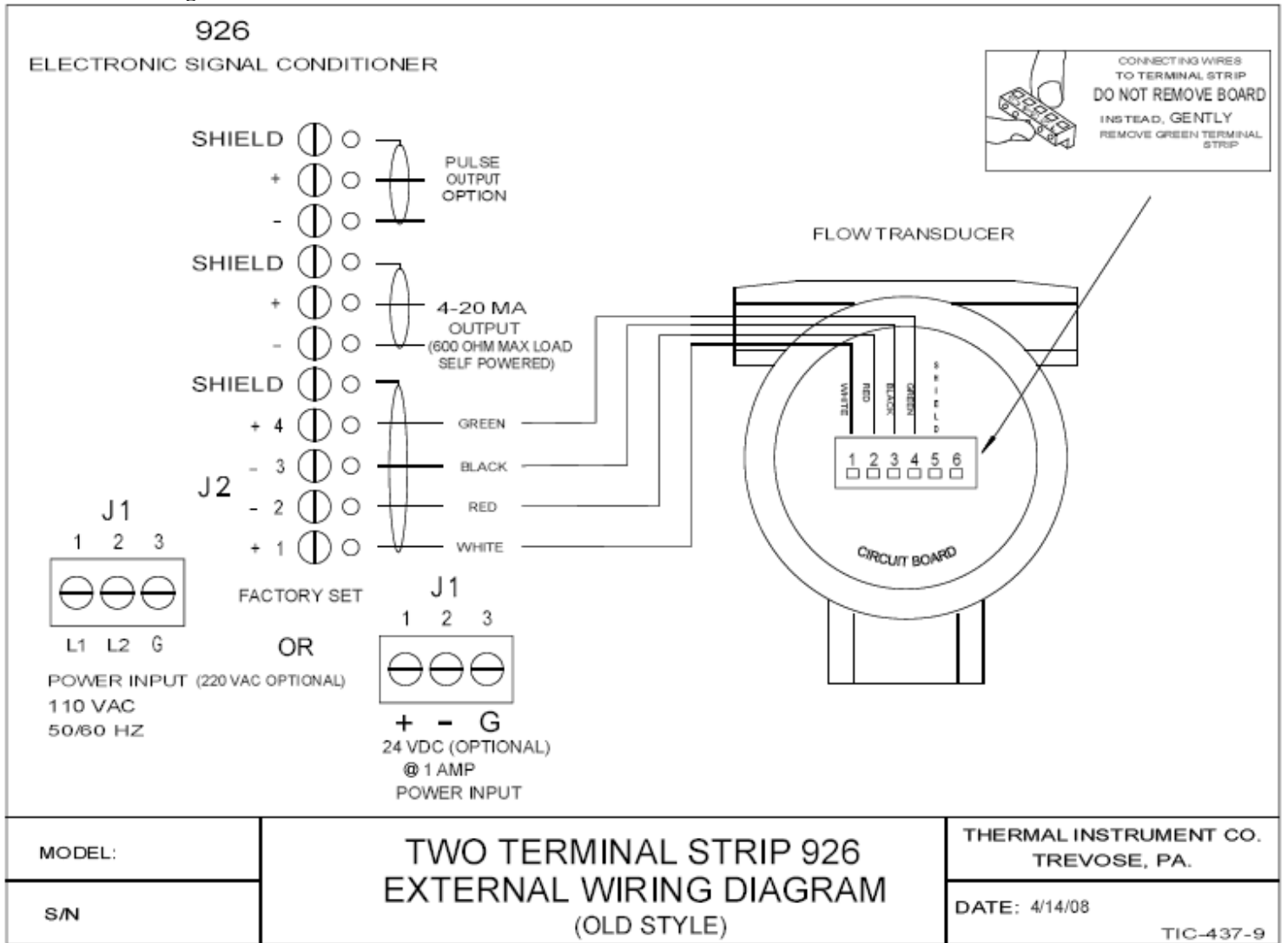

Figure #11

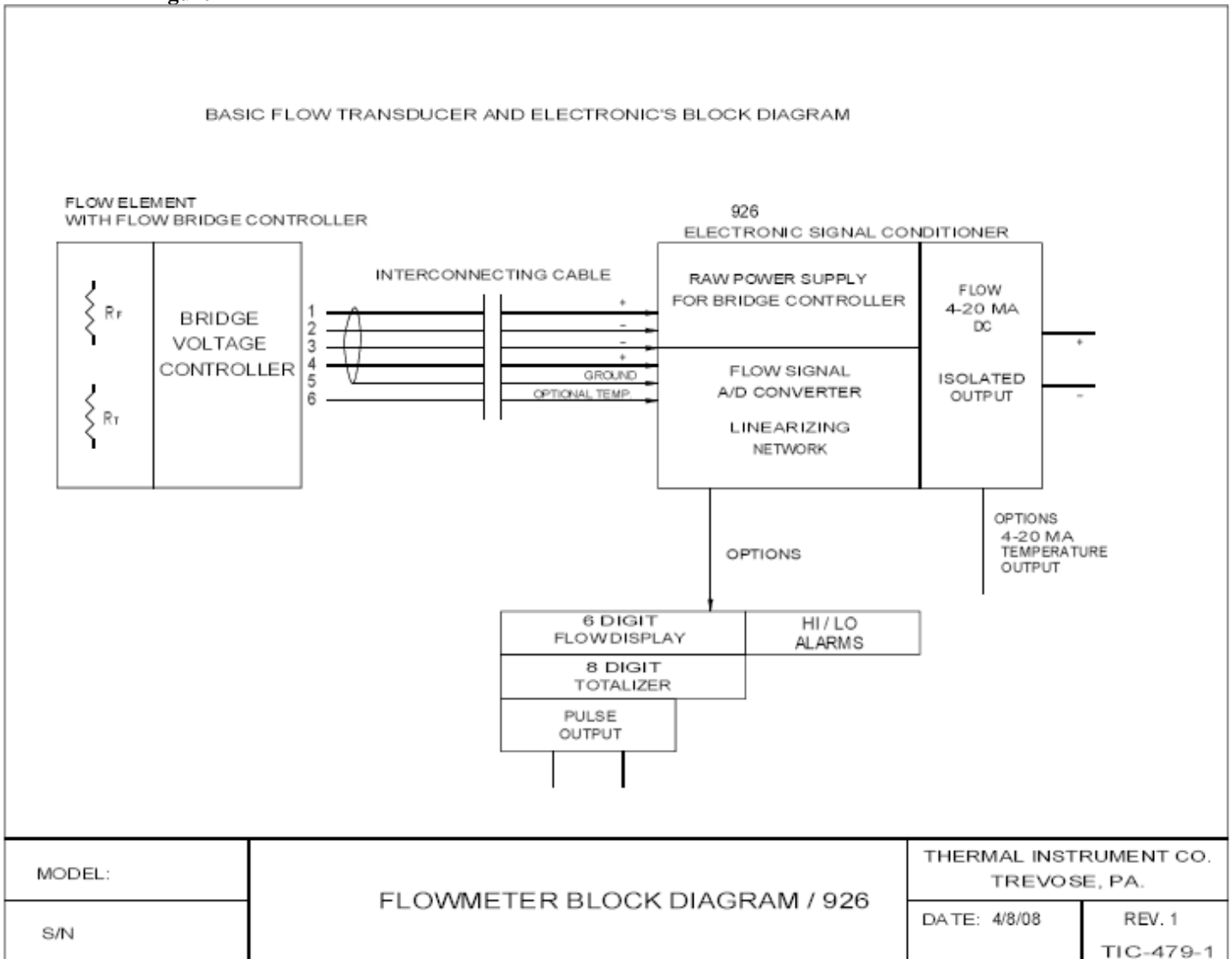

Figure #12

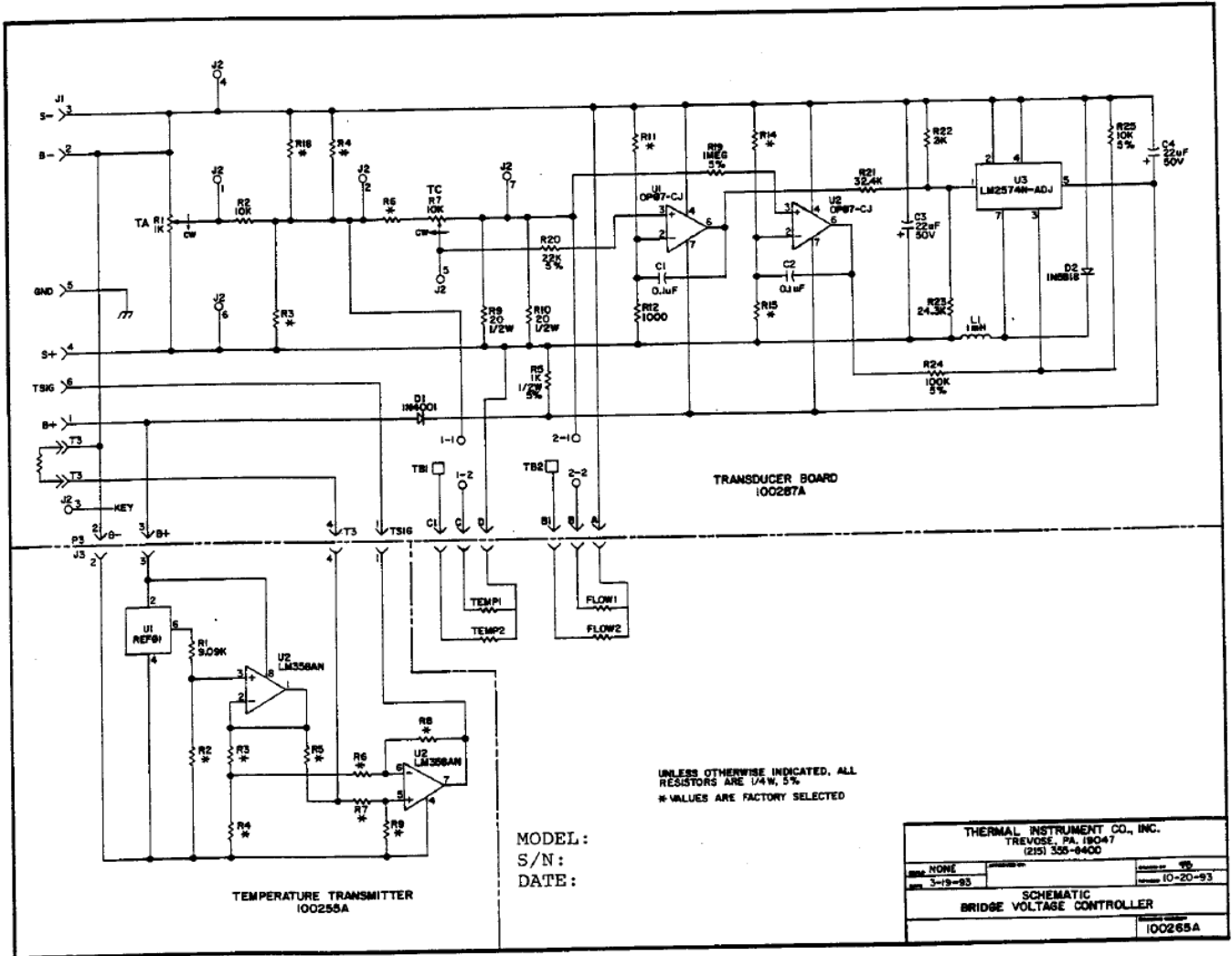
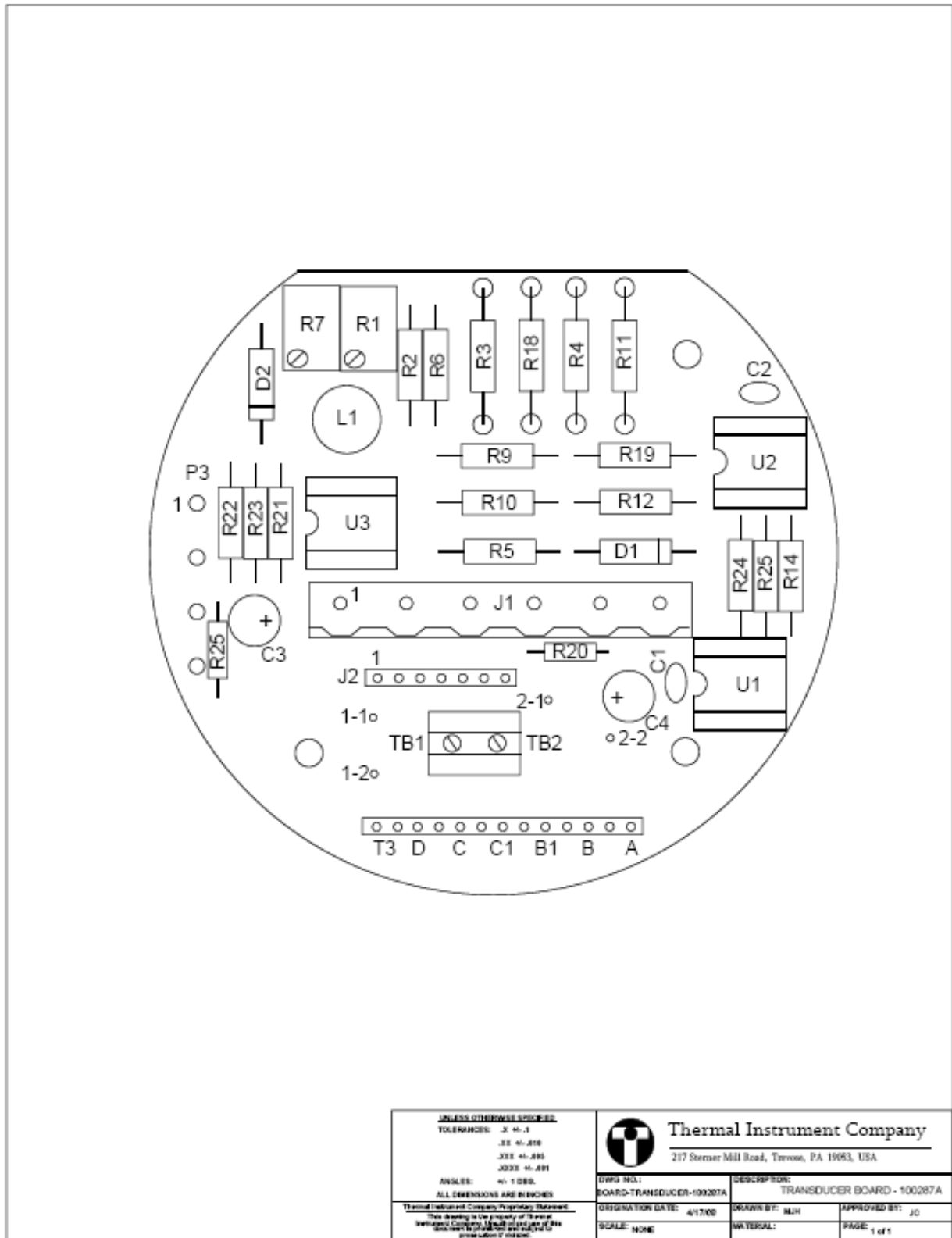



Figure #13



<p>UNLESS OTHERWISE SPECIFIED:</p> <p>TOLERANCES: .X .X-1 .XX .X-10 .XXX .X-100 .XXXX .X-1000</p> <p>ANGLES: .X-1000</p> <p>ALL DIMENSIONS ARE IN INCHES</p> <p><small>Thermal Instrument Company Proprietary Statement This drawing is the property of Thermal Instrument Company. It shall not be used, copied, or reproduced in any form without the written permission of Thermal Instrument Company.</small></p>	 <p>Thermal Instrument Company 217 Steiner Mill Road, Tyrone, PA 16883, USA</p>	
	<p>DWG NO.: BOARD-TRANSDUCER-100207A</p> <p>ORIGINATOR DATE: 4/17/08</p> <p>SCALE: NONE</p>	<p>DESCRIPTION: TRANSDUCER BOARD - 100207A</p> <p>DRAWN BY: MJH</p> <p>APPROVED BY: JD</p> <p>PAGE: 1 of 1</p>